

EN

English, 1

FR

Français, 21

WDV2200XCD

Contents

Washer-dryer safety 2

Installation instructions 3-4-5

Unpacking and leveling
Removing the transit screws
Minimum installation spacing
Exhaust requirements

Connecting water inlet
Drainage
Connecting the drain hose
Under sink method
Electrical
Technical information

Operating instructions 6-7-8

Control panel
Wash cycle table
Product description
Detergent dispenser drawer
Bleach cycle
Wash cycles
Dry cycles
Wash + dry cycles
Display
First-time use
Daily use
Pausing a cycle
Opening the door, if necessary
Changing a running wash cycle
At the end of the wash cycle
Options
Tips and suggestions
Accessories
Opening the porthole door manually

Cleaning & maintenance 9-10

Checking the water supply hose
Cleaning the mesh filters in the water inlet valves
Cleaning the detergent dispenser
Cleaning the water filter / draining residual water

Transport and handling 11

Troubleshooting 12-13

After-sales service 14

RV/Marine winterization 15

Warranty 16

WASHER-DRYER SAFETY

Your safety and the safety of others are very important.

We have provided many important safety messages in this manual and on your appliance. Always read and obey all safety messages.



This is the safety alert symbol.

This symbol alerts you to potential hazards that can kill or hurt you and others.

All safety messages will follow the safety alert symbol and either the word "DANGER" or "WARNING." These words mean:

! DANGER

You can be killed or seriously injured if you don't immediately follow instructions.

! WARNING

You can be killed or seriously injured if you don't follow instructions.

All safety messages will tell you what the potential hazard is, tell you how to reduce the chance of injury, and tell you what can happen if the instructions are not followed.

IMPORTANT SAFETY INSTRUCTIONS

WARNING: To reduce the risk of fire, electric shock, or injury to persons when using the dryer, follow basic precautions, including the following:

- Read all instructions before using the washer.
- Do not wash articles that have been previously cleaned in, washed in, soaked in, or spotted with gasoline, dry-cleaning solvents, other flammable, or explosive substances as they give off vapors that could ignite or explode.
- Do not add gasoline, dry-cleaning solvents, or other flammable, or explosive substances to the wash water. These substances give off vapors that could ignite or explode.
- Under certain conditions, Hydrogen gas may be produced in a hot water system that has not been used for 2 weeks or more. HYDROGEN GAS IS EXPLOSIVE. If the hot water system has not been used for such a period, before using the appliance, turn on all hot-water faucets and let the water flow for several minutes. This will release any accumulated hydrogen gas. As the gas is flammable, do not smoke or use an open flame during this time.
- Turn off water faucets when appliance is not in use to relieve pressure on hoses and valves and to minimize leakage if a break or rupture occurs.
- Do not allow children to play on or in the washer. Close supervision of children is necessary when the washer is used near children.
- Before the washer is removed from service or discarded, remove the door or lid.
- Do not reach into the washer if the drum, tub or agitator is moving.
- Do not install or store the washer where it will be exposed to the weather.
- Do not tamper with controls.
- Do not repair or replace any part of the washer or attempt any servicing unless specifically recommended in this manual or in published user-repair instructions that you understand and have the skills to carry out.
- See Installation Instructions for grounding instructions.
- Do not use replacement parts that have not been recommended by the manufacturer (e.g. parts made at home using a 3D printer).

SAVE THESE INSTRUCTIONS

IMPORTANT SAFETY INSTRUCTIONS

WARNING: To reduce the risk of fire, electric shock, or injury to persons when using the dryer, follow basic precautions, including the following:

- Read all instructions before using the dryer.
- Do not place items exposed to cooking oils in your dryer. Items contaminated with cooking oils may contribute to a chemical reaction that could cause a load to catch fire. To reduce the risk of fire due to contaminated loads, the final part of a tumble dryer cycle occurs without heat (cool down period). Avoid stopping a tumble dryer before the end of the drying cycle unless all items are quickly removed and spread out so that the heat is dissipated.
- Do not dry articles that have been previously cleaned in, washed in, soaked in, or spotted with gasoline, dry-cleaning solvents, or other flammable or explosive substances as they give off vapors that could ignite or explode.
- Do not allow children to play on or in the dryer. Close supervision of children is necessary when the dryer is used near children.
- Before the dryer is removed from service or discarded, remove the door to the drying compartment.
- Do not reach into the dryer if the drum is moving.
- Do not install or store the dryer where it will be exposed to the weather.
- Do not tamper with controls.
- Under certain conditions, Hydrogen gas may be produced in a hot water system that has not been used for 2 weeks or more. HYDROGEN GAS IS EXPLOSIVE. If the hot water system has not been used for such a period, before using the appliance, turn on all hot-water faucets and let the water flow for several minutes. This will release any accumulated hydrogen gas. As the gas is flammable, do not smoke or use an open flame during this time.
- Do not repair or replace any part of the dryer or attempt any servicing unless specifically recommended in this Use and Care Guide or in published user-repair instructions that you understand and have the skills to carry out.
- Do not use fabric softeners or product to eliminate static unless recommended by the manufacturer of the fabric softener or product.
- Do not use clothes dryer fabric softener in combo units.
- Do not use heat to dry articles containing foam rubber or similarly textured rubber-like materials.
- Keep area around the exhaust opening and adjacent surrounding areas free from the accumulation of lint, dust, and dirt.
- The interior of the dryer and exhaust vent should be cleaned periodically by qualified service personnel.
- See Installation Instructions for grounding instructions.
- Do not use replacement parts that have not been recommended by the manufacturer (e.g. parts made at home using a 3D printer).
- Turn off water faucets to relieve pressure on hoses and valves and to minimize leakage if a break or rupture occurs.

SAVE THESE INSTRUCTIONS

INSTALLATION INSTRUCTIONS

⚠️ WARNING

Excessive Weight Hazard

Use two or more people to move and install appliance.

Failure to do so can result in back or other injury.

⚠️ WARNING - "Risk of Fire"

- Clothes dryer installation must be performed by a qualified installer.

Install the clothes dryer according to the manufacturer's instructions and local codes.

- Do not install a clothes dryer with flexible plastic venting materials. If flexible metal duct is installed, it must be of a specific type identified by the appliance manufacturer as suitable for use with clothes dryers. Flexible venting materials are known to collapse, be easily crushed, and trap lint. These conditions will obstruct clothes dryer airflow and increase risk of fire.

- To reduce the risk of severe injury or death, follow all installation instructions.

- Save these instructions.

Install the clothes washer-dryer according to the manufacturer's instructions and local codes.

UNPACKING AND LEVELING

Unpacking

1. Remove the washer-dryer from its packaging.
2. Make sure that the washer-dryer has not been damaged during the transportation process. If it has been damaged, contact the retailer and do not proceed any further with the installation process. Dispose of/recycle all packaging materials.

Leveling

1. Install the washer-dryer on a flat sturdy floor, without resting it up against walls, furniture cabinets or anything else.

2. If the floor is not perfectly level, compensate for any unevenness by tightening or loosening the adjustable front feet (see figure); the angle of inclination, measured in relation to the worktop, must not exceed 2°.

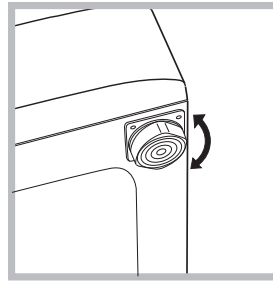

Leveling the machine correctly will provide it with stability, help to avoid vibrations and excessive noise and prevent it from shifting while it is operating.

REMOVING THE TRANSIT SCREWS

For transportation, the inside of the machine is supported by screws, rubber grommets and spacers on the back panel. Before using the washer-dryer, these items MUST be removed.

Important: Transit screws and spacers must be removed before operating the machine to allow proper operation of the machine and to prevent damage to the appliance.

After positioning the washer-dryer near the installation location, remove the four screws (see figure), with the rubber grommets and plastic spacers that are attached to them.

Important: Retain the transit screws, spacers and rubber tubes. These items should be reinstalled to prevent damage if or when you transport the machine in the future.

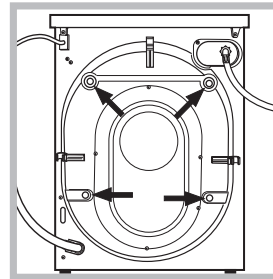

MINIMUM INSTALLATION SPACING

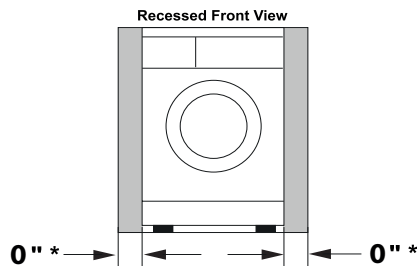

This machine may be installed free standing as well as in a recessed area, closet, or alcove. The installation spacing is in inches and is the minimum acceptable.

*Additional spacing should be considered for easy installation, servicing and compliance with local codes and ordinances. Installations must conform with the minimum dimensions indicated.

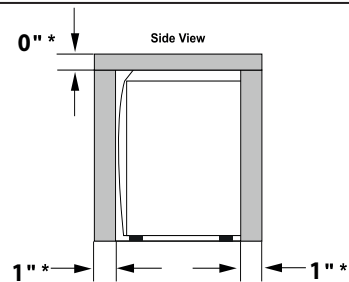

Floor must support 280 lbs. and be a solid level surface. To avoid damage to the flooring, do not install on carpet.

RV/Marine Installations - When locating the appliance in a towable trailer or watercraft, position the machine over the axles or mid-ship where movement is at a minimum. For RV or marine applications, please visit the Splendide website or call 1-800-356-0766 for the available installation kits.

If a cabinet door is installed, a min. opening of 8 sq. in. should be provided for make up air. Louvered doors with equivalent air opening are acceptable. Allow clearances behind door(s) to avoid rubbing between back of cabinet door(s) and front control panel. Additional clearances for all, door and floor molding may be required.

EXHAUST REQUIREMENTS

WARNING: Risk of fire. Do not install a booster fan in the exhaust duct.

Note: The booster fan warning does not apply to clothes dryers intended to be installed in a multiple clothes dryer system, with an engineered exhaust duct system that is installed per the clothes dryer manufacturer's guidelines.

Follow these requirements when installing the exhaust for this washer-dryer:

- The appliance shall not be exhausted into a chimney, a wall, a ceiling, an attic, a crawl space, or a concealed space of a building.
- Only rigid or flexible metal duct shall be used for exhausting. Contact Westland Sales at 1-800-356-0766 for recommended metal venting kits.
- In Canada, only those foil-type flexible ducts, if any, specifically identified for use with the appliance by the manufacturer shall be used. In the United States, only those foil-type flexible ducts, if any, specifically identified for use with the appliance by the manufacturer and that comply with the UL 2158A, shall be used.
- The exhaust duct shall be 4" (102 mm) in diameter.
- The maximum duct length shall be no greater than 7.9 ft (2.4 m), and the number of bends shall not exceed 2 elbows.
- The total length of flexible metal duct shall not exceed 7.9 ft (2.4 m).
- The duct shall not be assembled with screws or other fastening means that extend into the duct and catch lint.

NOTE: Exhaust ducts should be as short and as straight as possible.

NOTE: Long exhaust ducting can extend drying time, collect lint and may affect drying performance.

For available venting kits, contact Westland Sales at 1-800-356-0766 or by email at service@westlandsales.com.

CONNECTING WATER INLET

If the water pipes you will be connecting to are new or unused, run the water until clear to remove any debris that could clog the water valve screens or valves before connecting the machine.

NOTE: Supply shut-off valves should be easily accessible.

Important: Water pressure **MUST** range within the values indicated on the "Technical Data" chart.

1. Screw the cold water fill hose (**C** blue connector) onto the cold water supply until tight.
2. Turn on the cold water supply and check for leaks, tighten if necessary.
3. Screw the hot water fill hose (**H** red connector) onto the hot water supply until tight.
4. Turn on the hot water supply and check for leaks, tighten if necessary.

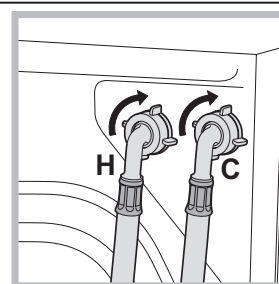

Important: Do not use excessive force. Damage to the couplings can result. The couplings should be tightened by hand; a tool should only be used if a leak occurs.

DRAINAGE

- **Standpipe Diameter/Capacity** - Needs a 1 1/4" minimum diameter standpipe with a minimum carry-away capacity of 7 gallons per minute.
- **Top of Standpipe** - Must be between 25" - 34" high from the bottom of the machine.

- **Outlet End of Drain Hose (provided with the unit)** - Must be at least 20" above the bottom of the washer-dryer. An air break must be available at the standpipe to avoid siphoning. No more than 6" of the drain hose should be inserted into the drain pipe to prevent siphoning.

CONNECTING THE DRAIN HOSE

It is possible for the water to be discharged into a sink, standpipe or drainpipe, but an air break must be available at a min. 20" height to prevent the machine from siphoning (Fig. 1).

Important: Make sure that the drain hose is not kinked and that water flow is not restricted.

- 3) Through the floor to a separate trap. The trap must be vented to prevent siphoning. To provide proper venting, install an Air Gap Kit (available at most hardware stores).
 - 4) To the faucet using a Faucet Adapter Kit (available separately).
- Use a U-Clamp (provided in your accessories packet) or suitable item to secure the outlet end of the drain hose (included in the plastic bag provided inside of your washer-dryer).
 - Insert the outlet end of the drain hose into the standpipe, wall or floor drain (Fig. 1).
- NOTE:** The outlet end of the drain hose **MUST** be at least 20" (50 cm) above the base of the machine. No more than 6" of the drain hose should be inserted into the drain pipe to prevent siphoning.
 - Use a strap, cable tie, or similar item to hold the hose or the U-Clamp in place.

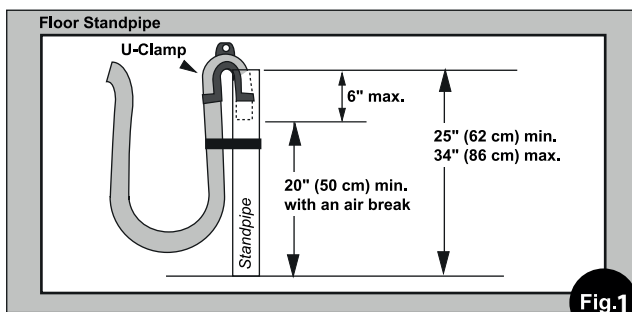

Fig.1

Standpipe Drain System - Installations require a minimum 1 1/4" (3.2 cm) diameter standpipe with a minimum carry away capacity of 7 gallons (26 liters) per minute.

Wall or Floor Standpipe Drain System - The top of the standpipe must be between 25" (62 cm) - 34" (86 cm) from the bottom of the washer-dryer (Fig. 2).

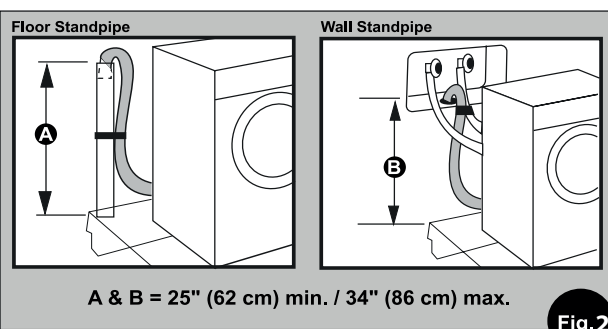

Fig.2

Sink Drainpipe System - Entry into the sink drain system must be above the trap (Fig. 3). When routing the drain hose through cabinets or walls, use a protective material such as electrical or duct tape to cover sharp edges that could damage the drain hose. Use a suitable clamp to secure the drain hose to the "Y" branch or the disposer. With a sink drainpipe system, you may connect directly:

- 1) to a disposer by following the manufacturer's attachment method.
- 2) to a "Y" branch tail piece (available at most hardware stores).

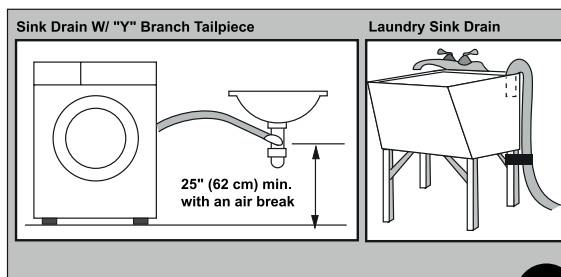
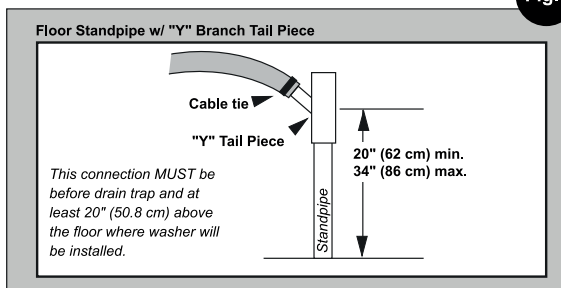
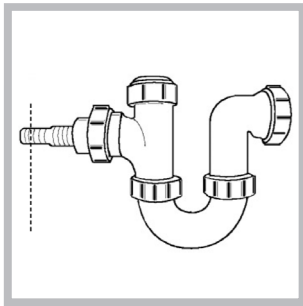

Fig.3



UNDER SINK METHOD



1. Cut the blocked end of the under sink drainage unit.

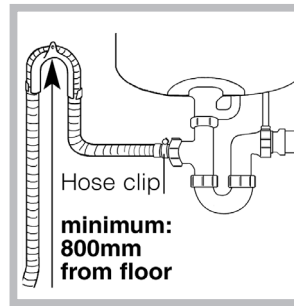

2. Fix the hooked end support a minimum of 24.4" (620 mm) from the floor.

3. Use a hose clip clamp to securely attach the grey drainage hose end to the under sink drainage unit using a hose clamp.

If you have...	You'll need...
no access to Hot/Cold water hookups	Splendide Faucet Adapter Kit, or equivalent.
to install a dryer vent and ducting in your RV or boat	Splendide Vent Kit, or equivalent.
concerns about the appliance shifting in your RV or boat	Splendide SecureFit bracket kit, or equivalent.
water damage concerns	Splendide Drain-A-Way Pan, or equivalent.
to make a 90° duct turn in less than 4.5"	Splendide 90° offset elbow, or equivalent

ELECTRICAL

- Machine Voltage/Amperage - 120V, 60 Hz, 12.5 Amp.
- Connection - 3-prong plug with 6' cord is provided with the machine.

- Circuit/Protector - 3-wire single phase, 120V, 60 Hz, AC, on a separate 15 Amp branch circuit.

⚠ WARNING

Electrical Shock Hazard

Plug into a grounded 3 prong outlet.

Do not remove ground prong.

Do not use an adapter.

Do not use an extension cord.

Failure to follow these instructions can result in death, fire, or electrical shock.

GROUNDING INSTRUCTIONS

For a grounded, cord-connected washer:
This washer must be grounded. In the event of a malfunction or breakdown, grounding will reduce the risk of electrical shock by providing a path of least resistance for electric current. This washer is equipped with a cord having an equipment-grounding conductor and a grounding plug. The plug must be plugged into an appropriate outlet that is properly installed and grounded in accordance with all local codes and ordinances.

WARNING: Improper connection of the equipment-grounding conductor can result in a risk of electric shock. Check with a qualified electrician or serviceman if you are in doubt as to whether the appliance is properly grounded.

Do not modify the plug provided with the appliance – if it will not fit the outlet, have a proper outlet installed by a qualified electrician.

TECHNICAL INFORMATION

Technical data	
Model	WDV2200XCD
Dimensions	width: 23.4" (59.5 cm) height: 33.24" - 33.75" (84.5 - 85.7 cm) depth: 22" (55.9 cm)
Weight	148 lbs
Minimum Installation Clearances	Sides: 0" Front / Back: 1" Top: 0"
Capacity	Washing: 2 to 15 lbs. (1 to 7 kg) Drying: 2 to 11 lbs (1 to 5 kg)

Electrical connections	Voltage: 120Volts, 12.5 Amp, 60 Hz
Water connections	Max. Pressure: 0.69 MPa (6.9 bar), 100 psi Min. Pressure: 0.05 MPa (0.5 bar), 7.5 psi
Max. Spin speed	up to 1200 RPM
This appliance was tested by UL and conforms with both Canadian and U.S. UL safety requirements and displays their Mark. US LISTED	

The model number and serial number of this machine may be found on the label attached to the front panel behind the door, and also on the label attached to the rear panel. You should note the model and serial numbers of this unit in the space provided. Retain this booklet as a permanent record of your purchase to aid in identification in the event of theft.

MODEL N. _____

SERIAL N. _____

THANK YOU FOR PURCHASING A SPLENIDE PRODUCT.

To receive more comprehensive assistance, register the appliance on www.splende.com

CONTROL PANEL

1. SUPER WASH / MUTE button
2. TIMED DRY/KEY LOCK button
3. ON/OFF button
4. PREWASH button and indicator light
5. START/PAUSE button
6. LOW HEAT button
7. DELAY START button
8. SPIN button
9. TEMPERATURE button
10. WASH CYCLE SELECTOR KNOB

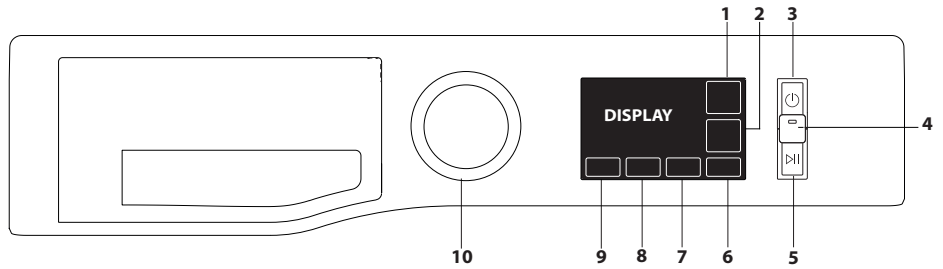

WASH CYCLE TABLE

Wash cycle	Temperature		Spin Speed	Recommended Load Size	Duration (minutes)	Detergents and Additives			
	Default/Max	Min				Default	Prewash (**)	Wash	Fabric softener
						1	2	3	4
Whites	Hot/Hot	Cold	Fast	Full	The duration of the wash cycles can be checked on the display.	○	●	○	○
Colors	Warm/Warm	Cold	Fast	Full		-	●	○	-
Regular	Warm/Hot	Cold	Fast	Full		○	●	○	-
Express	Warm/Warm	Cold	Fast	Full		-	●	○	-
Dry Cotton	-	-	-	Half		NOTE: A high spin is carried out during the 2:25' Timed Dry using the Cotton Dry cycle.			
Perm Press	Warm/Warm	Cold	Fast	Half		-	●	○	-
Lightly Soiled	Warm/Warm	Cold	Fast	Half		-	●	○	-
Dry Synthetic	-	-	-	Half		-	-	-	-
Delicates	Cold/Cold	Cold	Fast	Half		-	●	○	-
Silk	Cold/Cold	Cold	Off	Quarter		-	●	○	-
Dry Wool	-	-	-	Half		-	-	-	-
Wool	Cold/Cold	Cold	Fast	Quarter		-	●	○	-
	-	-	-	Empty		-	-	-	●
Rinse + Spin	Cold/Cold	Cold	Fast	Full		-	-	-	-
Spin + Drain *	-	-	Fast	Full		-	-	-	-

● Required dosage ○ Optional dosage
 - The recommended load size refers to the visual size of the load in the drum i.e. "half" means the drum should be approximately half full.

NOTE: This clothes dryer's Government energy certifications were based on the Dry Cotton / Timed Dry Cycle / 2 hours and 25 minutes, and Maximum Drying Temperature Setting.

The cycle duration indicated on the display or instruction manual is an estimate based on standard conditions. The actual duration may vary in relation to several factors, such as the temperature and pressure of the incoming water, ambient temperature, amount of detergent, load quantity and type, load balancing and any additional options selected.

* By selecting the "Spin + Drain" cycle and excluding the spin cycle, the washer-dryer will drain only.

** Prewash & Bleach cannot both be used in the same cycle. If desired, you must choose only one of these options.

PRODUCT DESCRIPTION

1. Top
2. Detergent dispenser drawer
3. Control panel
4. Door handle
5. Porthole door
6. Drain pump (behind the cover panel)
7. Cover panel (removable)
8. Adjustable feet (2)

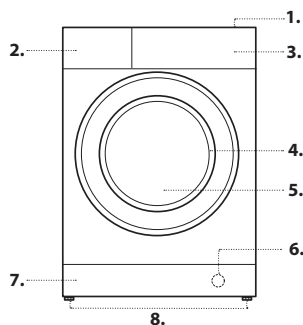

DETERGENT DISPENSER DRAWER

compartment 1: Pre-wash detergent (powder)
compartment 2: Detergent for the wash cycle (powder or liquid)

If liquid detergent is used, it is recommended that the removable plastic partition A (supplied) be used for proper dosage. If powder detergent is used, place the partition into slot B.

compartment 3: Additives (fabric softeners, etc.)
extra compartment 4: Bleach

NOTE: Use powder detergent for white cotton garments, for pre-washing, and for washing with hot temperatures.

NOTE: Splende recommends using 1 to 2 tbsp. of a bio-friendly fabric softener, or similar brand per wash load. These softeners tend to appear light in color and dissolve more quickly in less water, minimizing build-up within your machine.

NOTE: Follow the instructions given on the detergent packaging.
IMPORTANT: Do not use fabric softener sheets.

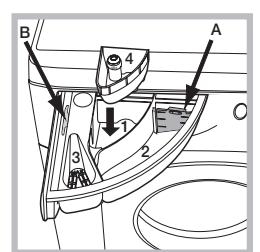

BLEACH CYCLE

Bleaching may only be performed in conjunction with wash cycles "Whites". If desired, pour the bleach into extra compartment 4; pour the detergent and softener into the corresponding compartments, then select one above-mentioned wash cycle. This option is recommended only for sturdy fabrics such as cottons, linens, etc..

NOTE: At the end of the cycle, there may be water standing in the bleach or other compartments, this is NORMAL. The Bleach compartment can be removed when not in use.

NOTE: Bleach & Prewash cannot both be used in the same cycle. If desired, you must choose only one of these options.

WASH CYCLES

Follow the instructions on the symbols of the garment's wash care label. The value indicated in the symbol is the maximum recommended temperature for washing the garment.



NOTE: The machine remembers your last option selection for Temperature and Spin Speed, and will use it for future wash cycles until you deselect that option i.e. if temperature is changed from the default setting on the Regular wash cycle, the machine will use this modified setting next time a Regular wash cycle is selected.

To restore factory defaults for Temperature and Spin Speed, refer to the WASH CYCLE TABLE.

Whites

Use this cycle when using liquid chlorine bleach.

Pour the bleach, the detergent and the additives into the relevant compartments.

Colors

This cycle is intended for use with colored fabrics, including cotton and synthetic garments. This cycle is designed to use less hot water, and is suitable for lightly soiled garments.

Regular

Suitable for washing normally soiled cottons and linens.

Express

This wash cycle was designed to wash lightly soiled garments quickly. By selecting this wash cycle ("Express" at WARM temperature), it is possible to wash different fabrics together (except for wool and silk items).

Perm Press

This cycle has less mechanical agitation and lower spinning speed designed to reduce wrinkles.

Lightly Soiled

This wash cycle was designed to wash lightly soiled garments quickly. By selecting this wash cycle ("Lightly Soiled" at WARM temperature), it is possible to wash different fabrics together (except for wool and silk items). For this cycle we recommend pretreating stains, shirt necks and wrists with specific antistain products.

This cycle is also used for winterization. Refer to the RV/MARINE WINTERIZATION section for details.

Delicates

For washing very delicate garments. It is advisable to turn the garments inside out before washing them.

Silk

Use special wash cycle to wash all silk garments. We recommend the use of special detergent which has been designed to wash delicate clothes.

Wool

For washing wool garments. For best results, use special detergents and do not exceed the maximum recommended load indicated in the "Wash Cycle Table."

Clean Washer

This cycle uses a higher water volume in combination with regular liquid chlorine bleach to thoroughly clean the inside of the washer-dryer. Do not use thickened or splash-less bleach for this cycle. When using this cycle, the drum must be empty.

Rinse + Spin

Rinses and then spins. For resilient garments.

Spin + Drain

Spins the load then empties the water. For resilient garments. If you exclude the spin cycle using the button, the machine will only drain.

DRY CYCLES

To perform a dry only cycle, turn the cycle selector knob to either Dry Cotton, Dry Synthetic, or Dry Wool. Then, press the button to select the Timed Dry option that you want. You may also choose the Low Heat option by pressing the button. Note that for best drying performance, avoid tightly packing the drum. The drum should be approximately half full for best performance.

Dry Cotton

Cottons and linen items.

Dry Synthetic

Synthetics and synthetic-blend items.

Dry Wool

Wool or gentle hand wash items.

A Timed Dry must be used with any of the three dry cycles above.

Timed Dry

To activate a Timed Dry, press the button and ensure the icon is lit on the display. To change the duration of the timed dry, press the button until the display shows the desired amount of time. To turn off the Timed Dry feature, press the button until the icon is no longer lit. Timed Dry options include Off, 25', 45', 1:05', 1:35', 2:05', 2:25'.

2:25' timed dry is only available for select cycles. When using the Timed Dry feature, the dry cycle will only last as long as the selected time, and then end regardless of the dryness level of the load inside the drum.

Low Heat

To activate Low Heat, press the button and ensure the icon is lit on the display. To turn off the Low Heat feature, press the button and ensure that the icon is no longer lit.

WASH + DRY CYCLES

To perform a wash + dry cycle, turn the cycle selector knob to the desired wash cycle. Then, use the **Timed Dry** and instructions on using the **Low Heat** option.

See **DRY CYCLES** section for instructions on how to activate a **Timed Dry** and instructions on using the **Low Heat** option.

DISPLAY

The display is useful when programming the washer-dryer and provides plenty of information.

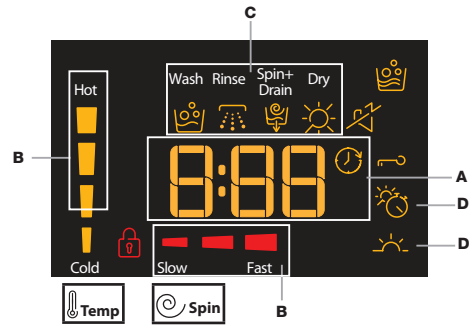

The duration of the available wash cycles and the remaining time of a running cycle appear in section **A** (Factors such as load size, modifiers, options selected, and water pressure may affect the time shown in the display. Tightly packed loads, unbalanced loads, or excessive suds may cause the washer-dryer to lengthen the cycle time as well; if the DELAYED START option has been set, the countdown to the start of the selected wash cycle will appear.

In section **B** pressing the corresponding button allows you to view the maximum spin speed and temperature values attained by the machine during the set wash cycle, or the values selected most recently, if these are compatible with the set wash cycle.

The "wash and dry cycle phases" corresponding to the selected wash cycle and the "wash and dry cycle phases" of the running wash cycle appear in section **C**:

- Wash
- Rinse
- Spin + Drain
- Dry

References **D** indicate the Dry options available (See "DRY CYCLES" section).

The "Delay Start" symbol , when lit, indicates that the set "delayed start" value has appeared on the display.

The symbol indicates the possibility to silence the key tones. While the mute is active, almost all sounds will be turned off. Only the sound signals and the alarms remain active, as well as the sound of the end of cycle. For activate/deactivate the mute press and hold button.

Key Lock

To lock the control panel, press and hold the "Key lock" button for approximately 3 seconds. The symbol will light up on the display to indicate that the control panel has been locked (with the exception of the "ON/OFF" button). This prevents unintentional changes to programs, especially with children near the machine. To unlock the control panel, press and hold the "Key lock" button for approximately 3 seconds.

Locked door indicator

When lit, the symbol indicates that the door is locked. To prevent any damage, wait until the symbol turns off before opening the door. To open the door while a cycle is in progress, press the START/PAUSE button ; if the symbol is off, the door can be opened.

FIRST-TIME USE

WARNING

Fire Hazard

Never place items in the washer that are dampened with gasoline or other flammable fluids.

No washer can completely remove oil.

Do not dry anything that has ever had any type of oil on it (including cooking oils).

Doing so can result in death, explosion, or fire.

Once the appliance has been installed, and before it is used for the first time, run a "Clean Washer " cycle with liquid chlorine bleach and no laundry.

DAILY USE



Prepare the laundry by following the suggestions appearing under the "TIPS AND SUGGESTIONS" section.

- Press the ON/OFF button .
- Open the door. Load the laundry while making sure not to exceed the maximum load quantity indicated in the wash cycle table.
- Pull out the detergent dispenser drawer and pour the detergent into the relevant compartments, as described in the "DETERGENT DISPENSER DRAWER" section.
- Close the door.
- The machine automatically displays the default temperature and spin speed values for the selected cycle, or the most recently used settings for that specific cycle.
- Select the desired wash or dry cycle.
- Select the desired options.
- Press and hold the START/PAUSE button to start the wash.

PAUSING A CYCLE

To pause the wash cycle, press the START/PAUSE >||| button again. To start the wash cycle from the point at which it was interrupted, press and hold the START/PAUSE >||| button again.

OPENING THE DOOR, IF NECESSARY

Shortly after a cycle starts, the  symbol turns on to signal that the door cannot be opened. While a wash cycle is running, the door remains locked. To open the door while a cycle is under way, for example, to add or remove garments, press the START/PAUSE >||| button to pause the cycle. If the  symbol is not lit, the door may be opened. Press and hold the START/PAUSE >||| button again to continue the cycle.

CHANGING A RUNNING WASH CYCLE

To change a wash cycle while it is in progress, pause the washer-dryer using the START/PAUSE >||| button, then select the desired cycle and press and hold the START/PAUSE >||| button again.

To cancel a cycle that has already begun, press and hold the ON/OFF  button. The cycle will be stopped and the machine will drain any remaining water in the drum, then shut off.

AT THE END OF THE WASH CYCLE

This will be indicated by the word "END" on the display; when the  symbol switches off, the door may be opened. Open the door, unload the laundry and switch off the machine. If you do not press ON/OFF  button, the washer-dryer will switch off automatically after about 15 minutes.

OPTIONS

- If the selected option is not compatible with the set wash cycle, the indicator light will flash accompanied by a buzzer and the option will not be activated.
- If the selected option is not compatible with another previously selected option, the indicator light will flash accompanied by a buzzer and the option will not be activated.

Super Wash

This option lengthens the cycle and uses more water, offering a high-performance wash.

Delay Start

To set a delayed start for the selected cycle, press the corresponding button repeatedly until the desired delay period is reached. When this option has been activated, the  symbol lights up on the display. To remove the delayed start setting, press the button until "OFF" appears on the display.

Temperature

Each wash cycle has a pre-defined temperature. To modify the temperature, press the  Temp" button.

The temperature has 4 selections: Cold - Lukewarm - Warm - Hot.

Hot



Cold

Spin

Each wash cycle has a pre-defined spin speed. To modify the spin speed, press the  Spin" button. The value will appear on the display.

The spin speed may be adjusted, or the spin cycle can be excluded altogether by turning OFF all leds.



Slow Fast

Prewash

This option performs an additional wash phase with cold water. Add an additional dose of detergent to the Prewash compartment if using this option. If this option is used, liquid chlorine bleach cannot be added.

TIPS AND SUGGESTIONS

When doing a wash + dry cycle:

The washer capacity is greater than the dryer capacity. Between the wash cycle and the dry cycle, remove some clothes if needed so that the drum is no more than half full, for best performance. This will allow more airflow during the dry cycle.

Divide the laundry according to:

Type of fabric (cotton, mixed fibres, synthetics, wool, garments to be hand-washed). Color (separate colored garments from whites, wash new colored garments separately). Delicates (small garments – such as nylon stockings – and items with hooks – such as bras: insert them in a fabric bag).

Empty the pockets:

Objects such as coins or lighters can damage the washer-dryer and the drum. Check all buttons.

ACCESSORIES

Contact our Technical Assistance Service to check if accessories are available for this washer-dryer model.

Technical Service: 1-800-356-0766

OPENING THE PORTHOLE DOOR MANUALLY

In the event that it is not possible to open the porthole door due to a powercut, and if you wish to remove the laundry, proceed as follows:

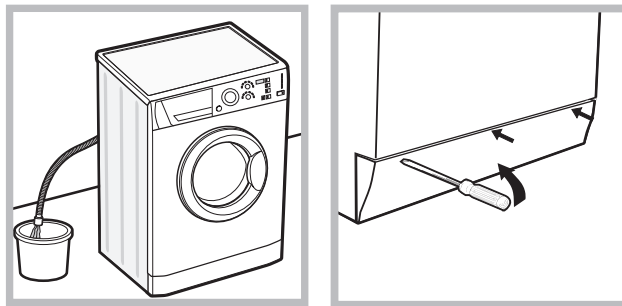

1. Remove the plug from the electrical socket.
2. Make sure the water level inside the machine is lower than the door opening; if it is not, remove excess water using the drain hose, collecting it in a bucket as indicated in the figure.
3. Using a screwdriver, remove the cover panel on the lower front part of the washer-dryer (see figure).

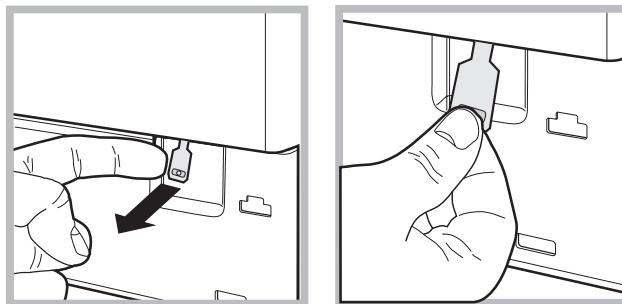

4. Unscrew and remove the screw that is holding the tab in place.
5. Pull outwards using the tab as indicated in the figure, until the plastic tie-rod is freed from its stop position; pull downwards and open the door at the same time.
6. Reposition the panel, making sure the hooks are securely in place before you push it onto the appliance.

CLEANING & MAINTENANCE

Do not use flammable fluids to clean the washer-dryer.

NOTE: Turn off the water supply after every wash. This will limit the wear of your appliance's water system and also prevent leaks. Unplug your appliance when cleaning it, while on vacation, and during all maintenance operations.

Cleaning the outside of the washer-dryer

The outer parts and rubber components of the appliance can be cleaned using a soft cloth soaked in lukewarm soapy water. Do not use solvents or abrasives.

Do not use glass or general purpose cleaners, scouring powder or similar to clean the control panel - these substances might damage the surfaces.

Cleaning the inside of the washer-dryer

The washer-dryer has a "Clean Washer" cycle for its internal parts; it must be run without any load in the drum. To optimise this cycle, use regular liquid chlorine bleach. Pour bleach into both the softener compartment and the extra bleach compartments, filling both to their respective max fill levels. Do not use thickened or splash-less bleach as excess suds may occur.

Note: Use of more liquid chlorine bleach than is recommended above could cause washer-dryer damage over time.

To start the program, close the door, turn the machine ON and set "Clean Washer" cycle.

To stop the cycle, press the START/PAUSE button.

We recommend running a cleaning cycle every 30 wash cycles.

Caring for the door and drum

Always leave the porthole door ajar in order to prevent unpleasant odors from forming.

For better care, periodically wipe the entire inside of the door with a damp cloth, and also inspect the gray-colored seal between the door opening and the drum for buildup. Wipe the seal clean using a damp.

CHECKING THE WATER SUPPLY HOSE

Check the inlet hose regularly (at least once per year) for brittleness and cracks. If damaged, replace it immediately. During the wash cycles, water pressure is very strong and a cracked hose could easily split open

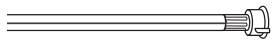
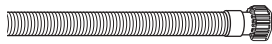

If the inlet hose has a transparent coating, periodically check if the color intensifies locally. If yes, the hose may have a leak and should be replaced.

NOTE: Do Not Use Second-Hand Hoses.

CLEANING THE MESH FILTERS IN THE WATER INLET VALVES

1. Close water tap and unscrew the inlet hose.
NOTE: Never use second-hand hoses.

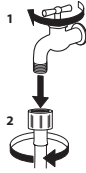

2. Now unscrew the inlet hose on the back of the washer-dryer by hand. Wipe any debris off of the mesh filter on the water inlet valve with your hand or using a squirt bottle to flush it out with water.

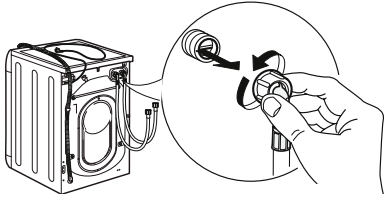

hand until it is seated on washer. Use pliers to tighten couplings an additional two-thirds turn. Turn on that hose's respective water supply, and check for leaks. Tighten if necessary. Repeat this step with the second inlet hose. Both inlet hoses must be connected for washer-dryer to work properly.
IMPORTANT: Do not overtighten or use tape or sealants on valve when attaching to faucets or washer-dryer.
IMPORTANT: Always inspect for leaks.

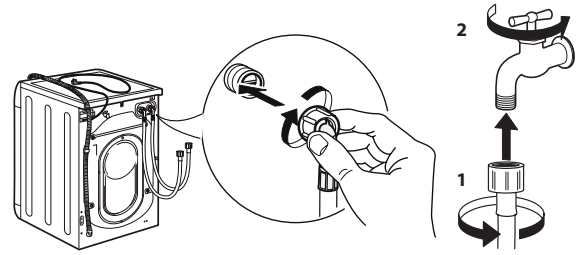

3. Attach one inlet hose to the water faucet. Screw on coupling by

CLEANING THE DETERGENT DISPENSER

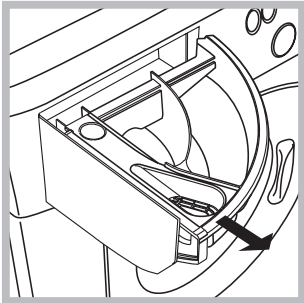

Remove the dispenser by rotating out to fully open position and then pulling it out (see figure). The drawer will slide on the handle.

You may find some residue buildup in or behind the washer-dryer's dispenser. Wipe the surfaces with a damp cloth and towel dry. Use an all-purpose surface cleaner, if needed.

Replace the dispenser by sliding it back onto the handle and make sure that it is correctly seated.

CLEANING THE WATER FILTER / DRAINING RESIDUAL WATER

If you used a hot wash program, wait until the water has cooled down before draining any water.

Clean the water filter regularly, to ensure that there are no obstructions in the filter, that could prevent the water from draining during or after a wash cycle.

NOTE: Perform the following procedure every 6 months.

1. Remove the cover panel: Using a screwdriver, do that which is shown in the following figure.

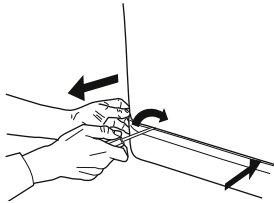

2. Container for the drained water: Place a low and wide container under the water filter in order to collect the residual water.

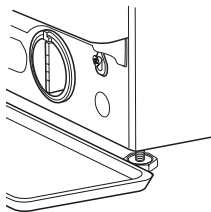

3. Drain the water: Slowly turn the filter counter-clockwise until all the water has come out. Allow the water to flow out without removing the filter. Once the container is full, close the water filter by turning it clockwise. Empty the container. Repeat the procedure until all the water has been drained.

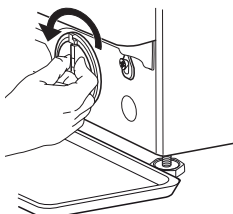

4. Remove filter: Lay a cotton cloth beneath the water filter, which can absorb a small amount of rest water. Then remove the water filter by turning it out counter-clockwise.

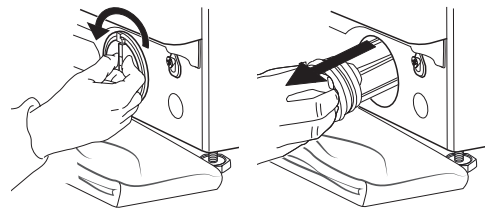

5. Clean the water filter: remove large clumps of lint by hand from the filter and place lint in a suitable waste container. Remove remaining residue from the filter by rinsing with water.

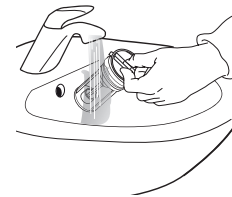

6. Insert the water filter and reinstall the cover panel: Reinsert the water filter again by turning it in clockwise direction. Make sure to turn it in as far as it goes; the filter handle must be in vertical position. To test water tightness of the water filter, you can pour about 1 liter (0.22 gal) of water into the detergent dispenser. Then reinstall the cover panel.

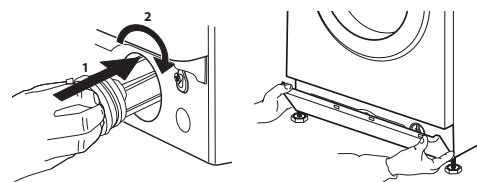

WARNING

Excessive Weight Hazard

Use two or more people to move and install appliance.

Failure to do so can result in back or other injury.

Do not lift the washer-dryer by holding it at the worktop.

1. Turn off the water, and unplug the washer-dryer.
2. Make sure that door and detergent dispenser are properly closed.
3. Disconnect the inlet hose from the water tap, and remove the drain hose from your draining point. Empty all the water remaining in the hoses and secure the latter so that they do not get damaged during transport.
4. Reinsert the four (4) transport bolts. Follow the instructions for



removing the transport bolts in the "Installation Instructions" in reverse order.

IMPORTANT: Do not transport the washer-dryer without having the transport bolts properly inserted.

TROUBLESHOOTING

Your washer-dryer could occasionally fail to work. Before contacting the Technical Assistance Service, make sure that the problem cannot be easily solved using the following list.



Anomalies	Possible causes / Solution
The washer-dryer does not switch on.	The appliance is not plugged into a grounded 3 prong outlet, or not enough to make contact. The outlet does not have power.
The wash cycle does not start.	The washer-dryer door is not closed properly. The ON/OFF  button has not been pressed. The START/PAUSE  button has not been pressed. The Delay Start button has been activated. The START/PAUSE button is activated by holding the button for a specific period of time (2 seconds). If you hold the button for too long, or too short of a time, the cycle will not start.
The washer-dryer does not fill with water or fault code (F8E1) appears on the display.	The water tap has not been opened. The water inlet hose is not connected to the tap. The hose is bent. Use the water supply hoses provided with the machine. If flood-safe hoses are used, it may restrict the flow of water. The water pressure is too low. The water inlet valve strainer may be plugged.
The washer-dryer continuously loads and unloads water.	The drain hose is not fitted between 25 and 34 inches from the floor. The free end of the hose is immersed in water. The drain pipe fits too tightly in the standpipe, or it is taped to the standpipe. The drain hose should be loose yet fit securely. Do not seal the drain hose with tape. The hose needs an air gap.
The washer-dryer does not drain and the fault code (F9E1) appears on the display.	Clean the pump filter (see Cleaning and Maintenance chapter). The drain hose is bent. The drainage duct is clogged.
The washer-dryer vibrates a lot during the spin cycle.	Transport bolts have been not removed correctly during installation. The washer-dryer is not leveled. The washer-dryer is tucked between furniture cabinets and the wall. Add some space on either side of the machine.
The washer-dryer leaks.	The water inlet hose is not screwed on properly. The detergent dispenser drawer is obstructed. The drain hose is not properly attached. The rubber washer (gasket) in the inlet hose is damaged.
The display visualises an error code (e.g.: F1E1, F4...).	Switch off the machine and unplug it, wait for approximately 1 minute and then switch it back on again. If the problem persists, contact the Technical Assistance Service.
There is too much foam.	The detergent is not suitable for machine washing (it should display the text "for washing machines" or "hand and machine wash", or the like). Too much detergent was used. Use only HE detergent.
The display shows cL.	Run a Clean Washer Cycle  . The machine will prompt you to run a clean washer cycle every 30 cycles. Refer to the CLEANING & MAINTENANCE section for instructions on how to run this cycle properly.
The display shows fault code FOE7.	Remove any clothes load during the Clean Washer cycle. The Clean Washer cycle will not run if there are any clothes inside the drum.
Display shows "--:-- --" at the end of the cycle.	This is normal behavior. If the machine takes longer to finish a cycle than displayed, then "--:-- --" will momentarily appear before the end of the cycle. The cycle may take longer due to redistributions required for an unbalanced load.
Water level appears low during wash.	This is normal for an HE front-load washer-dryer. The washer-dryer senses load size and adds the correct amount of water for optimal cleaning.
Access door won't open.	Door lock may be activated due to high water level. Run a Spin + Drain cycle to drain out the water. Power may have been lost. Ensure the machine is powered. You may unplug and then plug the machine back in.

Washer-dryer takes longer time than shown on the machine's display.	Water pressure is too low.
	Voltage supplied to the machine is too low.
	Excessive foam.
	An unbalanced load may cause the machine to adjust multiple times before performing a spin.
Water turns on at the start of the dry cycle.	This is normal. A small amount of water is used to fill a pressure trap, which prevents hot air from escaping through the dispenser during the dry cycle.
Wrinkling	Incorrect sorting.
	The drum is overloaded.
	Incorrect wash cycle.
	Clothes matted to the drum after spin.
Poor drying performance.	The drum is overloaded / there is not sufficient airflow to dry the load.
	Verify water supply connections are connected properly to the hot and cold valves.
	Verify that water supply is turned on.
	Not selecting a long enough dry time can lead to poor dry performance. Select a longer timed dry.
	For a Dry Only cycle, load may be too damp. Perform a Spin+Drain to help remove excess moisture.
Kinked or crushed exhaust hose.	
Dryer does not start, OR, Dry cycle lasts 0 minutes, and immediately ends after starting.	The Timed Dry option may be set to 0 minutes or is off. See the Operating Instructions section for instructions on how to select a Timed Dry.
Dryer performance has decreased over time.	Continual oversudsing from using too much/wrong kind of detergent or fabric softener.
	The internal drum to case hose is clogged. Run a Clean Washer  cycle.
The display shows fault code F5E4.	The door needs to be opened between every 3 consecutive cycles. Open the door and restart the cycle.

AFTER-SALES SERVICE

BEFORE CALLING THE AFTER-SALES SERVICE

1. See if you can solve the problem by yourself with the help of the suggestions given in the **TROUBLESHOOTING** section.

2. Switch the appliance off and back on again to see if the fault persists.

IF AFTER THE ABOVE CHECKS THE FAULT STILL OCCURS, GET IN TOUCH WITH THE NEAREST AFTER-SALES SERVICE

To receive assistance, call our Splendide Technical Service/ Assistance Department toll-free at 1-800-356-0766 or email us at service@westlandsales.com.

When contacting our Client After sales service, always specify:

- a brief description of the fault;
- the model and serial number of your washer-dryer (this can be found on the label behind the door)

- the service number (number after the word Service on the rating plate that can be found behind the door).

SERVICE 0000 000 00000



- your full address;
- your telephone number.

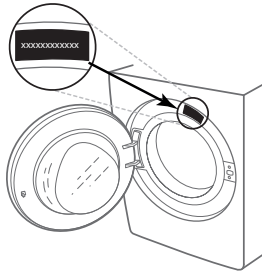

Splendide

Splendide Technical Service
15650 SE 102nd Ave
Clackamas, Oregon 97015 - USA

1-800-356-0766

Local Phone: 503-655-2563
service@westlandsales.com

RV/MARINE WINTERIZATION

SPECIAL WINTERIZATION INSTRUCTIONS FOR RV/MARINE INSTALLATIONS:		
To Winterize your Clothes Washer-Dryer	Optional Winterization Instructions	To use your washer-dryer again,
<p style="text-align: center;">WINTERIZE</p> <p>If you're currently pumping anti-freeze through your fresh water system, you can follow these steps to winterize your washer-dryer machine:</p> <ol style="list-style-type: none"> 1. With machine power OFF, advance cycle selector knob to "Lightly Soiled"; 2. Press the Power button, then ensure that the water temperature setting is set to HOT. Press and hold START. Let the machine run for 1 minute and 45 seconds. During this time, the drum will rotate, then all water inlet valves will be activated for a short period, followed by a brief pause of movement; 3. During the brief pause, press and hold the Power button to turn power OFF. <p>Note: If you have not seen antifreeze entering the machine (soap dispenser drawer), repeat Steps 1 & 2;</p> <ol style="list-style-type: none"> 4. Advance cycle selector knob to Spin + Drain; 5. Press the Power button, then press and hold START. 6. After letting antifreeze drain completely from drum, press the Power button to turn power OFF. FINISHED. 	<p style="text-align: center;">Winterization Option</p> <ol style="list-style-type: none"> 1. With washer-dryer power OFF, pour ½ quart of RV-type antifreeze into washer-dryer drum; 2. Close door. Select "Spin + Drain" cycle; 3. Press the Power button, then press and hold START. let the washer-dryer run for 1 to 2 minutes; 4. Press the Power button to turn power OFF. 5. Unplug washer-dryer from electrical outlet (or disconnect power); 6. Turn water supply faucets OFF. Disconnect inlet hoses from faucets; 7. Drain remaining water from the hoses. FINISHED. 	<p style="text-align: center;">DE-WINTERIZE</p> <ol style="list-style-type: none"> 1. If applicable, reconnect water inlet hoses to corresponding HOT/COLD faucets. Turn faucets ON. NOTE: Check water inlet hoses and pump periodically (see CLEANING & MAINTENANCE section); 2. Plug machine into appropriate electrical outlet (see ELECTRICAL section) - OR reconnect power supply; 3. With washer-dryer power OFF, pour bleach into both compartment '3' and the extra bleach compartment '4' of the Dispenser Drawer, filling both to their respective max fill levels. Do not use thickened or splash-less bleach as excess suds may occur. 4. Advance the cycle selector knob to "4". 5. Press the Power button, then press and hold the Start button. 6. Allow machine to run through the complete cycle to clean out any remaining antifreeze. FINISHED.
		

IMPORTANT - DO NOT DISCARD

Keep this page with your owners manual for future reference



ONE-YEAR LIMITED WARRANTY (USA & CANADA ONLY)

WHO IS COVERED BY THIS WARRANTY

This limited one-year warranty ("Warranty") is given only to the original end-use/retail purchaser (the "First Using Purchaser") of the accompanying Splendide product(s) (the "Splendide Product").

If you purchased this Splendide Product from someone other than an authorized Splendide reseller/dealer in the United States or Canada, or if the Splendide Product was used (including but not limited to floor models or refurbished products) prior to your purchase, then you are not the First Using Purchaser and the Splendide Product that you purchased is not covered by this Warranty. This Warranty is not transferable.

WHAT IS COVERED BY THIS WARRANTY

Splendide will repair or replace any part of the Splendide Product which fails due to a defect in materials or workmanship when used under normal home-use conditions.

This Warranty applies only to Splendide Products purchased and used in the United States or Canada. Subject to the exclusions below, for Splendide Products purchased in, but used outside, the United States or Canada, this Warranty covers only warranty service within the United States or Canada (and does not include shipping outside the United States or Canada).

LENGTH OF THE WARRANTY

This Warranty runs for a period of one (1) year from the date of the original purchase by the First Using Purchaser. Please note that a copy of your original purchase receipt showing the purchase date and the vendor's name and address are required to obtain service under this Warranty. For the purposes of determining the applicable warranty period, please note that any and all replaced or repaired parts shall assume the identity of the original.

WHAT IS NOT COVERED BY THE WARRANTY (EXCLUSIONS) This Warranty does not cover:

1. Improper installation, delivery, maintenance and/or improper operation of the Splendide Product.
2. Damage caused if the Splendide Product has not been used in compliance with the electricity or gas supply specifications printed on the rating plate.

3. Failure of or damage to the Splendide Product if it is altered, abused, misused, or used for other than the intended purpose, or if it is used commercially.

4. Service trips to your home to provide instructions on the use of your Splendide Product.

5. This warranty excludes door gaskets, plastic, fuses, water valves, removal from inaccessible location, maintenance cleaning, water damage of any kind, loss of use of vehicle, time inconvenience, gasoline expense, telephone, travel, lodging, loss or damage to personal property or revenues. This warranty does not cover any installation method that results in excessive movement of product after installation resulting in premature failure.

6. Damage caused by neglect, accident, fire, floods or acts of God.

7. Physical Damage to the appearance of your Splendide Product including, without limitation, scratches, rust, dents, warping, peeling and the like.

8. Damage caused by transportation.

9. Replacement of any consumable or degradable item or accessory including, but not limited to: plugs, cables, batteries, light bulbs, fluorescent tubes and starters, covers and filters, or replacement of any removable parts made of glass or plastic.

10. Damage caused after delivery.

11. Water damage of any kind.

12. A Splendide Product not accessible to provide required service.

13. Problems arising from other than defects in materials or workmanship.

14. Travel time when installed in a recreational vehicle or marine application.

This Warranty is void if the Splendide Product is altered, serviced, maintained, dismantled, or otherwise interfered with by any person who is not authorized by Splendide.

15. Labor when installed in a marine application.

TO THE EXTENT PERMITTED BY LAW, THIS WARRANTY IS IN LIEU OF ALL OTHER WARRANTIES, WRITTEN OR ORAL, WHETHER EXPRESSED BY AFFIRMATION, PROMISE, DESCRIPTION, DRAWING, MODEL OR SAMPLE. ANY AND ALL WARRANTIES OTHER THAN THIS ONE, WHETHER EXPRESS OR IMPLIED, INCLUDING IMPLIED WARRANTIES OF MERCHANTABILITY AND FITNESS FOR A PARTICULAR PURPOSE, ARE HEREBY DISCLAIMED. IMPLIED WARRANTIES INCLUDING, BUT NOT LIMITED TO, THE IMPLIED WARRANTIES OF MERCHANTABILITY AND FITNESS THAT CANNOT BE EXCLUDED BY LAW, SHALL BE LIMITED TO THE SAME DURATION AS THIS WARRANTY. EXCEPT FOR

THAT REPAIR OR REPLACEMENT AS DESCRIBED ABOVE, SPLENIDIE SHALL NOT BE LIABLE FOR ANY DIRECT, INDIRECT, INCIDENTAL OR CONSEQUENTIAL DAMAGES OR SPECIFIC RELIEF.

Some States and Provinces do not allow the exclusion or limitation of incidental or consequential damages and/or implied warranties, so the above limitations or exclusions may not apply to you. This Warranty gives you specific legal rights and you may also have other legal rights which vary from State to State or Province to Province.

WHAT YOU SHOULD DO TO OBTAIN WARRANTY SERVICE

All repairs or warranty service must be provided by Splendide/Westland Sales or an Authorized Splendide Service Center. All service questions can be answered by contacting Westland Sales. CONTACT WESTLAND SALES before any service company is brought in. With prior authorization from Westland sales, any qualified appliance service company may work on this appliance.

WESTLAND SALES

15650 SE 102nd Avenue - Clackamas, OR 97015

1-800-356-0766 (LOCAL: 503-655-2563)

www.westlandsales.com

service@westlandsales.com

Please remember to provide us with your Splendide Product's model number and serial number.

Please note that a copy of your original purchase receipt showing the purchase date and the vendor's name and address are required to obtain service under this Warranty. If the Splendide Product is located in an area where service by an Authorized Splendide Service Center is not available, you may be responsible for a trip charge or you may be required to bring the Splendide Product to an Authorized Splendide Service Center for service.

The foregoing are your sole (i.e., only) and exclusive remedies under this Warranty. This Warranty is the only warranty that Splendide is giving for this Splendide Product. This Warranty replaces all other agreements and understandings that you may have with Splendide or its representatives.